

DAEWOO



Instruction manual



Thank you for purchasing the Digital Home Cinema System.
Please read this manual thoroughly before making connections
and turning on the power.
Following the instructions in this manual will enable you to
obtain optimum performance and listening enjoyment from your
Daewoo Digital Home Cinema System.
Please retain this manual for future reference.





The Speaker Systems are optional.

DIGITAL HOME CINEMA SYSTEM DV-115

DAEWOO

Important Safeguards

WARNING : TO PREVENT FIRE OR ELECTRIC SHOCK, DO NOT EXPOSE THIS APPLIANCE TO RAIN OR MOISTURE.

	CAUTION RISK OF ELECTRIC SHOCKS DO NOT OPEN	
<p>CAUTION : TO REDUCE THE RISK OF ELECTRIC SHOCK, DO NOT REMOVE COVER(OR BACK). NO USER SERVICEABLE PARTS INSIDE. REFER SERVICING TO QUALIFIED SERVICE PERSONNEL.</p>		
	<p>THIS SYMBOL IS INTENDED TO ALERT THE USER TO THE PRESENCE OF UNINSULATED "DANGEROUS VOLTAGE" WITHIN THE PRODUCT'S ENCLOSURE THAT MAY BE SUFFICIENT MAGNITUDE TO CONSTITUTE A RISK OF ELECTRIC SHOCK TO PERSONS.</p>	
	<p>THIS SYMBOL IS INTENDED TO ALERT THE USER TO THE PRESENCE OF IMPORTANT OPERATING AND MAINTENANCE(SERVICING) INSTRUCTIONS IN THE LITERATURE ACCOMPANYING THE APPLIANCE.</p>	

CAUTION

TO PREVENT ELECTRIC SHOCK, DO NOT USE THIS POLARIZED AC PLUG WITH AN EXTENSION CORD, RECEPTACLE OR OTHER OUTLET UNLESS THE BLADES CAN BE FULLY INSERTED TO PREVENT BLADE EXPOSURE.

LASER SAFETY

THIS UNIT EMPLOYS A LASER. ONLY QUALIFIED SERVICE PERSONNEL SHOULD REMOVE THE COVER OR ATTEMPT TO SERVICE THIS DEVICE DUE TO POSSIBLE EYE INJURY.
CAUTION : USE OF ANY CONTROLS, ADJUSTMENTS, OR PROCEDURES OTHER THAN THOSE SPECIFIED HEREIN MAY RESULT IN HAZARDOUS RADIATION EXPOSURE.

CAUTION : TO PREVENT ELECTRIC SHOCK, MATCH WIDE BLADE OF PLUG TO WIDE SLOT, FULLY INSERT.
ATTENTION : POUR EVITER LES CHOCs ELECTRIQUES, INTRODUIRE LA LAME LA PLUS LARGE DE LA FICHE DANS LA BORNE CORRESPONDANTE DE LA PRISE ET POUSSER JUSQU'AU FOND.

Important Safety Instructions

- All the safety and operating instructions should be read before the appliance is operated.
- The safety and operating instructions should be retained for future reference.
- All warnings on the appliance and in the operating instructions should be adhered to.
- All operating and use instructions should be followed.

1. Water and Moisture - The appliance should not be used near water - for example, near a bathtub, washbowl, kitchen sink, laundry tub, in a wet basement, or near a swimming pool, and the like.

PORTABLE CART WARNING



FIGURE 2

2. Carts and Stands - The appliance should be used only with a cart or stand that is recommended by the manufacturer.
3. An appliance and cart combination should be moved with care. Quick stops, excessive force, and uneven surfaces may cause the appliance and cart combination to overturn.
4. Wall or Ceiling Mounting - The appliance should be mounted to a wall or ceiling only as recommended by the manufacturer.

Important Safeguards

5. Ventilation - The appliance should be situated so that its location or position does not interfere with its proper ventilation. For example, the appliance should not be situated on a bed, sofa, rug, or similar surface that may block the ventilation openings; or, placed in a built-in installation, such as a bookcase or cabinet that may impede the flow of air through the ventilation openings.
6. Heat - The appliance should be situated away from heat sources such as radiators, heat registers, stoves, or other appliances (including amplifiers) that produce heat.
7. Power Sources - The appliance should be connected to a power supply only of the type described in the operating instructions or as marked on the appliance.
8. Grounding or Polarization - The precautions that should be taken so that the grounding or polarization means of an appliance is not defeated.
9. Power - Cord Protection - Power-supply cords should be routed so that they are not likely to be walked on or pinched by items placed upon or against them, paying particular attention to cords at plugs, convenience receptacles, and the point where they exit from the appliance.
10. Protective Attachment Plug - If the appliance is equipped with an attachment plug having overload protection. This is a safety feature. See Instruction Manual for replacement or resetting of protective device. If replacement of the plug is required, be sure the service technician has used a replacement plug specified by the manufacturer that has same overload protection as the original plug.
11. Cleaning - The appliance should be cleaned only as recommended by the manufacturer.
12. Power Lines - An outdoor antenna should be located away from power lines.
13. Outdoor Antenna Grounding - If an outside antenna is connected to the receiver be sure the antenna system is grounded so as to provide some protection against voltage surges and built-up static charges. Article 810 of the National Electrical Code, ANSI/NFPA 70, provides information with regard to proper grounding of the mast and supporting structure, grounding of the lead-in wire to and antenna-discharge unit, size of grounding conductors, location of antenna-discharge unit, connection to grounding electrodes and requirements for the grounding electrode. See Figure 1.
14. Nonuse Periods - The power cord of the appliance should be unplugged from the outlet when left unused for a long period of time.
15. Object and Liquid Entry - Care should be taken so that objects do not fall and liquids are not spilled into the enclosure through openings.
16. Damage Requiring Service - The appliance should be serviced by qualified service personnel when:
 - a) The power-supply cord or the plug has been damaged; or
 - b) Objects have fallen, or liquid has been spilled into the appliance; or
 - c) The appliance has been exposed to rain; or
 - d) The appliance does not appear to operate normally or exhibits a marked change in performance; or
 - e) The appliance has been dropped, or the enclosure damaged.
17. Servicing - The user should not attempt to service the appliance beyond that described in the operating instructions. All other servicing should be referred to qualified service personnel.

"NOTE TO CATV SYSTEM INSTALLER:
THIS REMINDER IS PROVIDED TO CALL THE SYSTEM INSTALLER'S ATTENTION TO ARTICLE 820-40 OF THE NEC THAT PROVIDES GUIDELINES FOR PROPER GROUNDING AND, IN PARTICULAR SPECIFIES THAT THE CABLE GROUND SHALL BE CONNECTED TO THE GROUNDING SYSTEM OF BUILDING, AS CLOSE TO THE POINT OF CABLE ENTRY AS PRACTICAL."

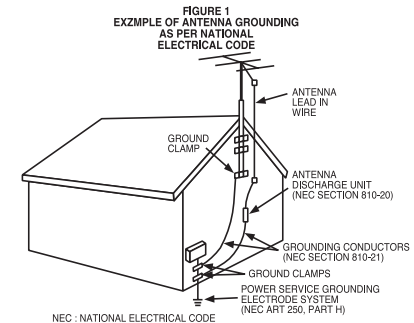

Precautions

1. Warranty Claim

You can find the serial number on the rear panel of this unit.
In case of warranty claim, please report this number.

2. Recording Copyright

Recording of copyrighted material for other than personal use is illegal without permission of the copyright holder.

3. AC Fuse

The fuse is located inside the chassis and is not user-serviceable. If power does not come on, contact your Daewoo authorized service center.

4. Power

WARNING
BEFORE PLUGGING IN THE UNIT FOR THE FIRST TIME, READ THE FOLLOWING SECTION CAREFULLY.

The voltage of the available power supply differs according to country or region. Be sure that the power supply voltage of the area where this unit will be used meets the required voltage (e.g., AC 230 V, 50 Hz or AC 120 V, 60 Hz) written on the rear panel.

Worldwide models are equipped with a voltage selector to conform to local power supplies. Be sure to set this switch to match the voltage of the power supply in your area before plugging in the unit.

5. Do not touch this unit with wet hands

Do not handle this unit or power cord when your hands are wet or damp. If water or any other liquid enters the case, take this unit to an authorized service center for inspection.

6. Location of this unit

- Place this unit in a well-ventilated location. Take special care to provide plenty of ventilation on all sides of this unit especially when it is placed in an audio rack. If ventilation is blocked, this unit may overheat and malfunction.

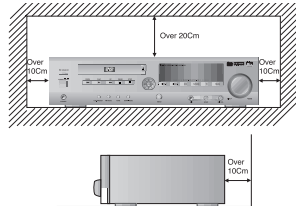

- Do not expose this unit to direct sunlight or heating units as this unit's internal temperature may rise and shorten the life of the pickup.
- Avoid damp and dusty places and places directly affected by vibrations from the speakers. In particular, avoid placing the unit on or above one of the speakers.
- Be sure this unit is placed in a horizontal position. Never place it on its side or on a slanted surface as it may malfunction.
- When you place this machine near a TV, radio, or VCR, the playback picture may become poor and the sound may be distorted. In this case, place the machine away from the TV, radio, or VCR.

7. Care

From time to time you should wipe the front and rear panels and the cabinet with a soft cloth. For heavier dirt, dampen a soft cloth in a weak solution of mild detergent and water, wring it out dry, and wipe off the dirt. Following this, dry immediately with a clean cloth.

Do not use rough material, thinners, alcohol or other chemical solvents or cloths since these could damage the finish or remove the panel lettering.

8. Notes on Handling

- Any changes or modifications in construction of this device which are not expressly approved by the party responsible for compliance could void the user's authority to operate the equipment.
- When shipping the machine, use the original shipping carton and packing materials. For maximum protection, repack the unit as it was originally packed at the factory.
- Do not use volatile liquids, such as insect spray, near the machine. Do not leave rubber or plastic products in contact with the machine for a long time. They will leave marks on the finish.
- The top and rear panels of the machine may become warm after a long period of use. This is not a malfunction.
- When the machine is not in use, be sure to remove the disc and turn off the power.
- If you do not use the machine for a long period, the unit may not function properly in the future. Turn on and use the machine occasionally.

9. To Obtain a Clear Picture

The machine is a high technology, precision device. If the optical pick-up lens and disc drive parts are dirty or worn down, the picture quality becomes poor. To obtain a clear picture, we recommend regular inspection and maintenance (cleaning or parts replacement) every 1,000 hours of use depending on the operating environment. For details, contact your nearest dealer.

10. Notes on Moisture Condensation

Moisture condensation damages the machine. Please read the following carefully.

Moisture condensation occurs, for example, when you pour a cold drink into a glass on a warm day. Drops of water form on the outside of the glass. In the same way, moisture may condense on the optical pick-up lens inside this unit, one of the most crucial internal parts of the machine.

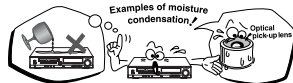

- Moisture condensation occurs in the following cases.
 - When you bring the machine directly from a cold place to a warm place.
 - When you use the machine in a room where you just turned on the heater, or a place where the cold wind from the air conditioner directly hits the unit.
 - In summer, when you use the machine in a hot and humid place just after you move the unit from an air conditioned room.
 - When you use the machine in a humid place.



- Do not use the machine when moisture condensation may occur. If you use the machine in such a situation, it may damage discs and internal parts. Remove the disc, connect the power cord of the machine to the wall outlet, turn on the machine, and leave it for two or three hours. After a few hours, the machine will have warmed up and evaporated any moisture. Keep the machine connected to the wall outlet and moisture condensation will seldom occur.

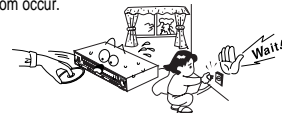

Table of Contents

Important Safeguards/Precautions/Table of Contents.....	2/3/4
---	-------

Getting Started

6

Features.....	6
Index to Parts and Controls.....	7/8/9
Preparing the Remote Controller, About This Instruction Manual, Note on Copyright	10
Notes on Discs.....	11
Connecting to a TV	12
Connecting to Audio/Video Equipment.....	13
Connecting Speakers, Positioning Speakers.....	14
Making Antenna Connections.....	15
Connecting to AC OUTLET on the Rear Panel, Connecting the Power/Turning on the machine.....	16
Speaker Setup.....	17

Basic Operation

18

Playing DVD Videos/Video CDs/MP3 CD/Audio CDs.....	18/19/20
Locating a Specific Title/Chapter/Track by Disc Menu.....	20
Locating a Specific Title/Chapter/Track by Disc Menu /Locating a Specific Title/Chapter/Track/MP3 File/Location.....	21/22
Radio Listening.....	23
Receiving FM stations with RDS/Using Microphone/Echo effect(Optional)	24/25
Various Functions Common to all the Sources.....	26
Enjoying the Sound Effects.....	27

Advanced DVD/VIDEO CD/MP3/Audio CD Operation

28

Playing Repeatedly.....	28
Playing in a Favorite Order.....	29
Playing in Random Order/Zooming a Picture	30
Selecting the Camera Angle.....	31
Selecting Subtitles Included on the DVD.....	32
Selecting the Audio Language/Sound Included on the Disc.....	33
Using Information on the On-Screen Display	34
Customizing the Function Settings.....	35/36/37

Additional Operation

37

Recording Using the Connected Equipment.....	38
--	----

Others

38

Troubleshooting/Accessories.....	39/40
Specifications.....	41
Active Subwoofer System.....	42/43

Features

◆ A/V Digital Receiver Features

- All channels 30 watts per channel min. RMS. into 6 ohms two channel driven, 1,000 Hz with no more than 0.2 % total harmonic distortion. (FTC)
- All channels 30 watts per channel min. RMS. into 6 ohms two channel driven, 1,000 Hz (DIN)
- DTS[®]*, Dolby[®]** Digital & Dolby Pro Logic[™] Decoders
- 6 DSP Listening Modes (DTS, Dolby Digital, Dolby Pro Logic, Theater, Stadium, Hall)
- Full Bandwidth Power to 5 Main Channels
- High-Current, Low-Impedance 6-Ohm Drive
- Dynamic Range Mode
- Bass & Treble Rotary Tone Controls

◆ DVD/VIDEO CD/MP3 CD/Audio CD Player Features

- Video CD and CD Disc Playback Capability
- Digital Audio Output for MD or CD Recording
- Component Video Outputs (Y, Cb, Cr)
- On-screen Display
- 10-Bit Video D/A Conversion
- 3-Mode "Zoom-In" Function
- 4-Mode Search (DVD title, chapter, CD track, time)
- Last Memory Play
- Programmed Memory Playback
- 3-Mode Random Memory Playback (title, chapter, track)
- 6-Mode Repeat (title, chapter, track, all tracks, memory, A-B section)

* Manufactured under license from Digital Theater Systems, Inc. US Pat. No.5,451,942 and other worldwide patents issues and pending, "DTS" and "DTS Digital Surround" are trademarks of Digital Theater Systems, Inc.© 1996 Digital theater Systems, Inc. All Rights reserved.

** Manufactured under license from Dolby Laboratories. "Dolby", "Pro Logic" and the double-D  symbols are trademarks of Dolby Laboratories. Confidential Unpublished Works. ©1992-1997 Dolby Laboratories, Inc. All rights reserved.

- Slow Motion DVD Playback (1/2, 1/3, 1/4, 1/5, 1/6 or 1/7 normal speed)
- Fast Forward/Reverse (x2, x8, x60, x120 normal speed)
- Multi Aspect Ratio (16:9 and 4:3)
- Multi Camera Angle
- 8-Language Soundtrack Capability
- 32 Subtitle Languages
- Parental Viewing Control
- Large Fluorescent Display with 2-Mode Display Dimmer (normal, dim)
- 2 Digital Inputs (1 coaxial, 1 optical)
- 1 S-Video Output
- Dedicated Line-Level Subwoofer Pre Out
- 2 A/V and 2 Audio Inputs
- Full Input/Output Cassette and Video Tape Loops For Easy Dubbing
- Headphone Jack (6.3 ϕ)
- 1 Switched AC Convenience Outlet
- Sleep Timer (Remote Control)
- 1 microphone input with own volume/echo control(Optional)

◆ High Fidelity FM/MW(AM) Tuner Features

- 30 FM/MW(AM) Random Presets
- Auto Scan Tuning
- FM Indoor Antenna
- MW(AM) Loop Antenna

Memory Preservation

This unit does not require memory preservation batteries. A built-in memory power back-up system preserves the contents of memory during power failures and even when the POWER switch is set to OFF.

The POWER switch must be set to ON in order to charge the back-up system. The memory preservation period after the unit has been turned off varies depending on climate and placement of the unit. On average, memory contents are protected over a period of a weeks after the time the unit has been turned off. This period is shorter when the unit is exposed to a very humid climate.







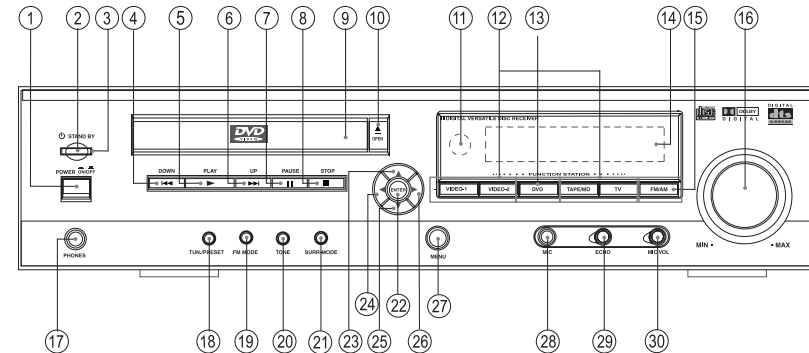



Index to Parts and Controls

For operational instructions, refer to the page indicated in brackets.

◆ Front panel



Front panel

- | | |
|--|---|
| 1. POWER ON/OFF switch | 16. MASTER VOLUME control |
| 2. STANDBY indicator | 17. PHONES jack |
| 3. STANDBY/ON button | 18. TUNE/PRESET button |
| 4. SKIP/SEARCH DOWN () button | 19. FM MODE button |
| 5. PLAY () button | 20. TONE button |
| 6. SKIP/SEARCH UP () button | 21. SURROUND MODE button |
| 7. PAUSE () button | 22. ENTER button |
| 8. STOP () button | 23. MOVE UP () button |
| 9. DVD/VIDEO CD/MP3 CD/audio CD disc tray | 24. MOVE LEFT () button |
| 10. OPEN/CLOSE () button | 25. MOVE DOWN () button |
| 11. Remote control sensor | 26. MOVE RIGHT () button |
| 12. Input selector : | 27. MENU button |
| VIDEO 1, VIDEO 2, TAPE/MD, TV buttons | 28. MIC jack(Optional) |
| 13. Input selector : DVD buttons | 29. ECHO LEVEL control(Optional) |
| 14. Display | 30. MIC VOL control(Optional) |
| 15. Input selector : TUNER buttons | |

Index to Parts and Controls

◆ Remote controller

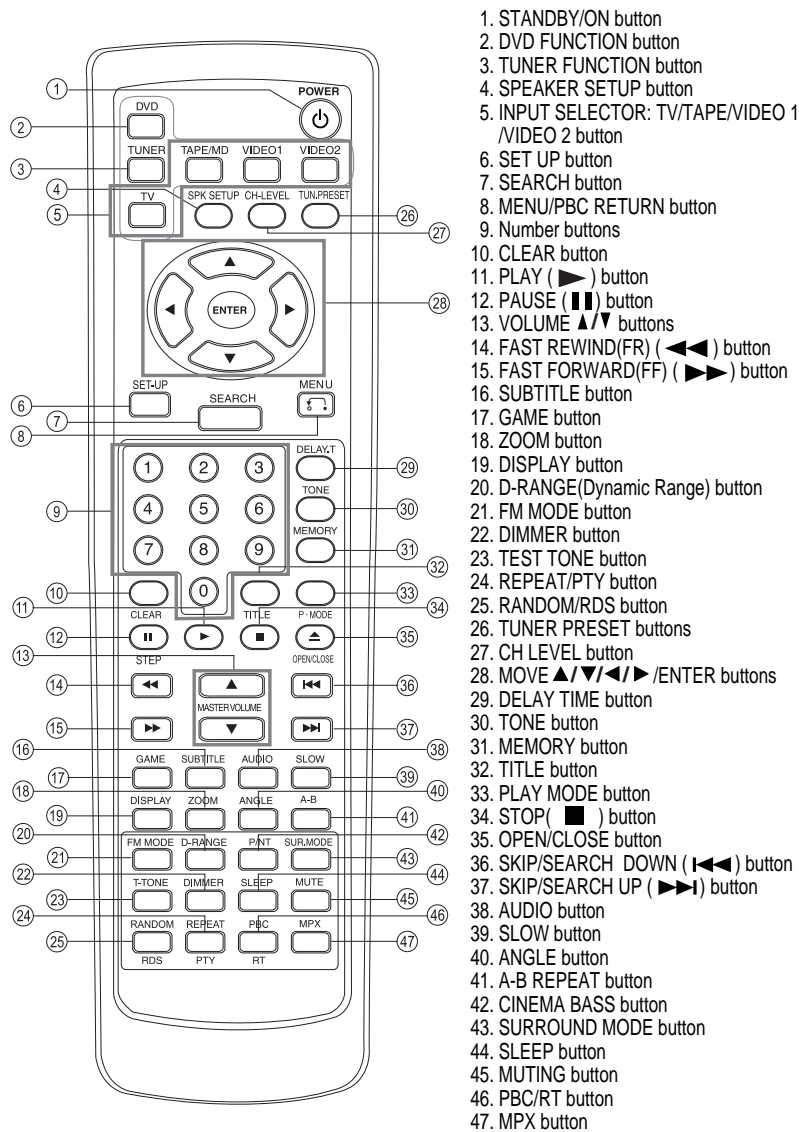

Index to Parts and Controls

◆ Display

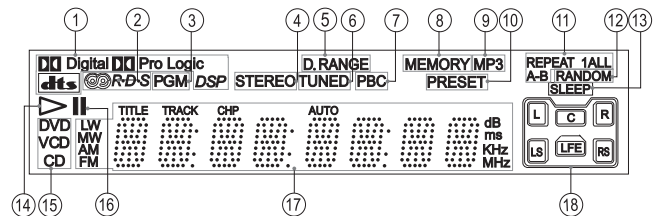

1. SURROUND MODE indicator
2. RDS indicator
3. PROGRAM indicator
4. STEREO indicator
5. DYNAMIC RANGE indicator
6. TUNED indicator
7. PBC(Playback Control) indicator
8. MEMORY indicator
9. MP3 indicator
10. PRESET indicator
11. REPEAT indicator
12. RANDOM indicator
13. SLEEP indicator
14. PLAY indicator
15. DVD/VCD/CD indicator
16. PAUSE indicator
17. MULTI FUNCTION indicator
18. SPEAKER CONFIGURATION indicator

◆ Rear Panel

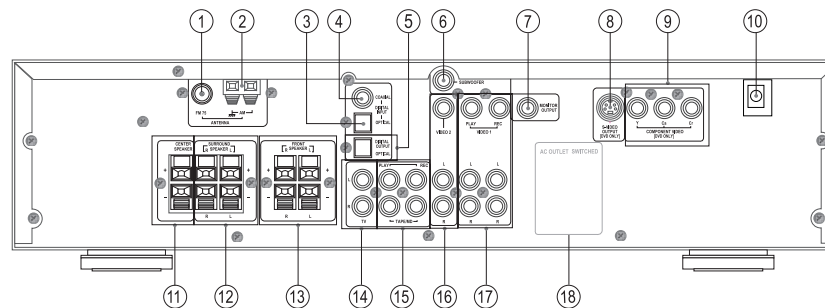

1. FM ANTENNA connector
2. AM ANTENNA connectors
3. DIGITAL INPUT OPTICAL jack
4. DIGITAL INPUT COAXIAL jack
5. DIGITAL OUTPUT OPTICAL jack
6. PRE OUT SUBWOOFER jack
7. MONITOR OUT jack
8. S VIDEO MONITOR OUT jack
9. COMPONENT VIDEO OUTPUT Y/Cb/Cr jacks
10. Power cord
11. CENTER SPEAKER connectors
12. SURROUND SPEAKERS connectors
13. FRONT SPEAKERS connectors
14. TV IN jacks
15. TAPE/MD IN PLAY(IN)/REC(REC) jacks
16. VIDEO 2 IN jacks
17. VIDEO 1 PLAY(IN)/REC(OUT) jack
18. AC outlet

Getting Started

Preparing the Remote Controller

Inserting the Batteries

1. Detach the battery cover.

2. Insert the batteries.

Be sure to match the + and - ends of the batteries with the diagram inside the battery compartment.

3. Attach the battery cover.

UM-4/ size AAA/ R03 x 2pcs

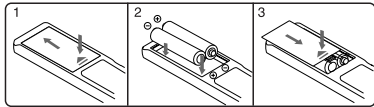

Notes

- Do not mix new batteries with old batteries or different kinds of batteries.
- To avoid corrosion, remove the batteries if the remote controller is not to be used for a long time.
- Remove dead batteries immediately to avoid damage from corrosion. If the remote controller does not operate smoothly, replace both the batteries at the same time.
- The life of the batteries supplied is about six months but this will vary depending on usage.

Using the Remote Controller

◆ **Pointing the remote controller in the right direction**

Point the remote controller toward the remote control sensor.

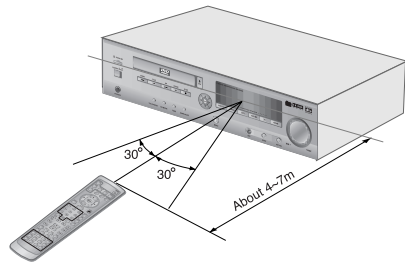

Notes

- Place the unit away from strong light such as direct sunlight or inverted fluorescent light which can prevent proper operation of the remote controller.
- Using another remote controller of the same type in the same room or using the unit near equipment which uses infrared rays may cause operational interference.
- Do not put any object such as a book on the remote controller. The buttons of the remote controller may be pressed by mistake and drain the batteries.
- Make sure the audio rack doors do not have colored glass. Placing the unit behind such doors may prevent proper remote controller operation.
- If there is any obstacle between the remote controller and the remote control sensor, the remote controller will not operate.

About This Instruction Manual

This instruction manual explains the basic procedures for operating of the machine. Some DVD videos are produced in a manner that allows specific or limited operation during playback. As such, the machine may not respond to all operating commands. Refer to instruction notes on discs.

A " " mark may appear on the TV screen during operation.

The " " mark means that the operation is not permitted by the machine or the disc.

Note on Copyright

It is forbidden by law to copy, broadcast, show, broadcast on cable, play in public, and rent copyrighted material without permission.

DVD videos are copy protected, and any recordings made from these discs will be distorted.

This product incorporates copyright protection technology that is protected by method claims of certain U.S. patents and other intellectual property rights owned by Macrovision Corporation and other rights owners. Use of this copyright protection technology must be authorized by Macrovision Corporation, and is intended for home and other limited viewing uses only unless otherwise authorized by Macrovision Corporation. Reverse engineering or disassembly is prohibited.

Notes on Discs

This section shows you how to handle, clean, and store discs.

On Handling Discs

- Do not touch the playback side of the disc.
- Do not attach paper or tape to discs.



On Cleaning Discs

- Fingerprints and dust on the disc cause picture and sound deterioration. Wipe the disc from the center outwards with a soft cloth. Always keep the disc clean.



- If you cannot wipe off the dust with a soft cloth, wipe the disc lightly with a slightly moistened soft cloth and finish with a dry cloth.
- Do not use any type of solvent such as thinner, benzene, commercially available cleaners or antistatic spray for vinyl LPs. It may damage the disc.

On Storing Discs

- Do not store discs in a place subject to direct sunlight or near heat sources.
- Do not store discs in places subject to moisture and dust such as a bathroom or near a humidifier.
- Store discs vertically in a case. Stacking or placing objects on discs outside of their case may cause warping.

Note on Region Numbers

The region number are allocated to machine and software according to where they are sold. DVDs can be played on this machine if their region number is the same or includes the same number, or if the DVD is marked "ALL". Confirm the region number for this machine before choosing discs. The number for machine is indicated on the rear panel.

On VIDEO CDs

This machine supports VIDEO CDs equipped with the PBC(Version 2.0) function. (PBC is the abbreviation of Playback Control.)

You can enjoy two playback variations depending on the type of disc.

- VIDEO CD not equipped with PBC function(Version 1.1) Sound and movies can be played on this machine in the same way as an audio CD.

- VIDEO CD equipped with PBC function (Version 2.0) In addition to operation of the VIDEO CD not equipped with the PBC function, you can enjoy playback with interactive software and with search function by using the menu displayed on the TV screen (Menu Playback). Some of the functions described in this Instruction Manual may not work with some discs.

Playable Discs

This machine can play back the following discs.

Disc Type	Contents	Disc size	Maximum playback time
DVD videos with an suitable region number or ALL	Digital Audio + Digital Video (MPEG2)	12 Cm	Approx. 240minutes (Single sided disc) Approx. 480minutes (Double sided disc)
		8 Cm	Approx. 80minutes (Single sided disc)
			Approx. 160minutes (Double sided disc)
VIDEO CDs (Version 1.0 / 1.1 / 2.0) or S-Video CD	Digital Audio + Digital Video (MPEG1)	12 Cm	Approx. 74 minutes
		8 Cm	Approx. 20 minutes
Audio CDs (PCM or dts)	Digital Audio	12 Cm	Approx. 74 minutes
		8 Cm (CD Single)	Approx. 20 minutes
CD-Rs, CD-RWs	Digital Video(MPEG1), Digital Audio or Only MP3 files	12 Cm	Approx. 74 minutes
		8 Cm (CD Single)	Approx. 20 minutes
CD-ROMs	Only MP3 Files	12 Cm	Approx. 640 MBytes
		8 Cm	Approx. 200 MBytes

- You cannot play back discs other than those listed above.
 - DVD with an un suitable region number
 - DVD-Audio - DVD-ROM - DVD-R - DVD-RAM
 - DVD-RW - DIVX Video Disc - VSD
 - CD-ROM - CDV - CVD
 - CD-G - SACD - SVCD - Photo CD, etc

- This machine uses the PAL/NTSC color system, and cannot play back DVD videos recorded in any other color system (SECAM, etc.).
- Avoid using heart-shaped or octagonal discs. Playing irregularly shaped discs may damage the internal mechanism of the machine.
- Do not use discs on which adhesive from adhesive tape or a disc label (if it is a rental disc) remains. Otherwise, you may not be able to eject the discs or the machine may become inoperative.

Notes : playing MP-3 CD

The machine can play only single session marked CD-R/RW for ISO9660, Joliet format. For other format, it cannot play the discs. When using the MP-3 CD, can control only play, pause, stop, skip up/down.

Connecting to a TV

◆ Before connecting

- Refer also to the instruction manual of the TV.
- When you connect the machine to the TV, be sure to turn off the power and unplug both the units from the wall outlets before making any connections.
- Connect the machine to the TV directly. If you connect the

machine to a VCR, TV/VCR combination, or video selector, the playback picture may be distorted as DVD videos are copy protected.

- Note that one audio/video connection cable connection cable are supplied.

Connecting to a TV without Color Difference Inputs

If the TV or monitor is equipped with an S video input, make the S video connection in addition to the normal video connection. The S video connection will provide higher quality picture playback.

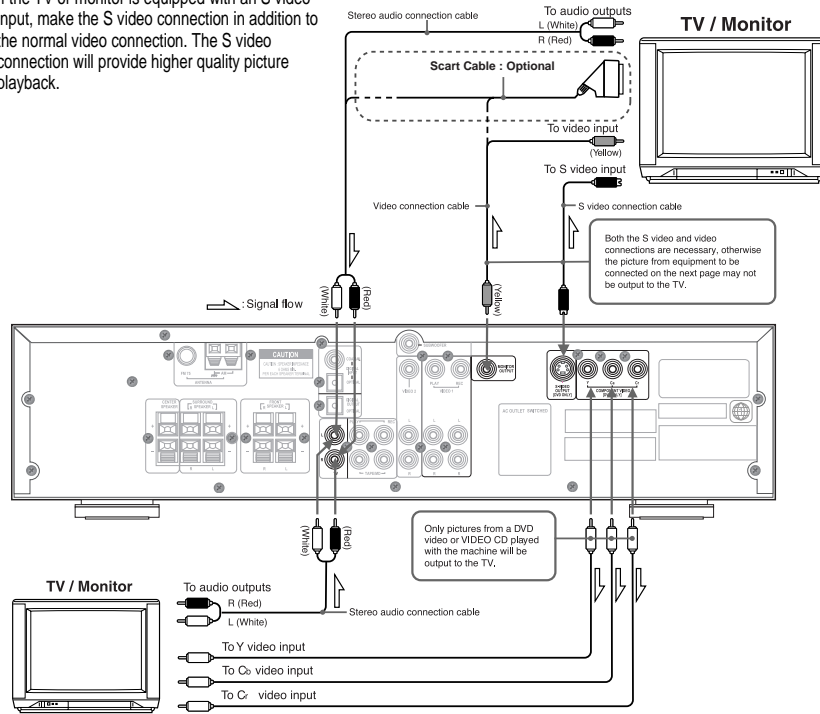

Connecting to a TV with Color Difference Inputs

If the TV or monitor is equipped with the color difference inputs, select the connection on the above. Connecting to these inputs allows you to enjoy higher quality picture playback compared to the above connection.

Notes

- Actual labels for color difference inputs may vary depending on the TV manufacturer (ex. Y/Cb/Cr, Y/R-Y/B-Y, Y/Pb/Pr or Component video).
- In some TVs or monitors, the color levels of the playback picture may be reduced slightly or the tint may change. In such a case, adjust the TV or monitor for optimum performance.

Caution

You may need to maximize the volume of the TV speaker(s) when you carry out steps in "Speaker Setup". Be sure to turn down the volume of the TV speaker(s) before changing the TV source input and using the TV speaker(s) as a normal TV speaker(s).

Connecting to Audio/Video Equipment

◆ Before connecting

- Refer also to the instruction manual of each component to be connected.
- When you connect the machine to audio/video equipment, be sure to turn off the power and unplug all the units from the wall outlets before making any connections.
- Connect the plugs securely.

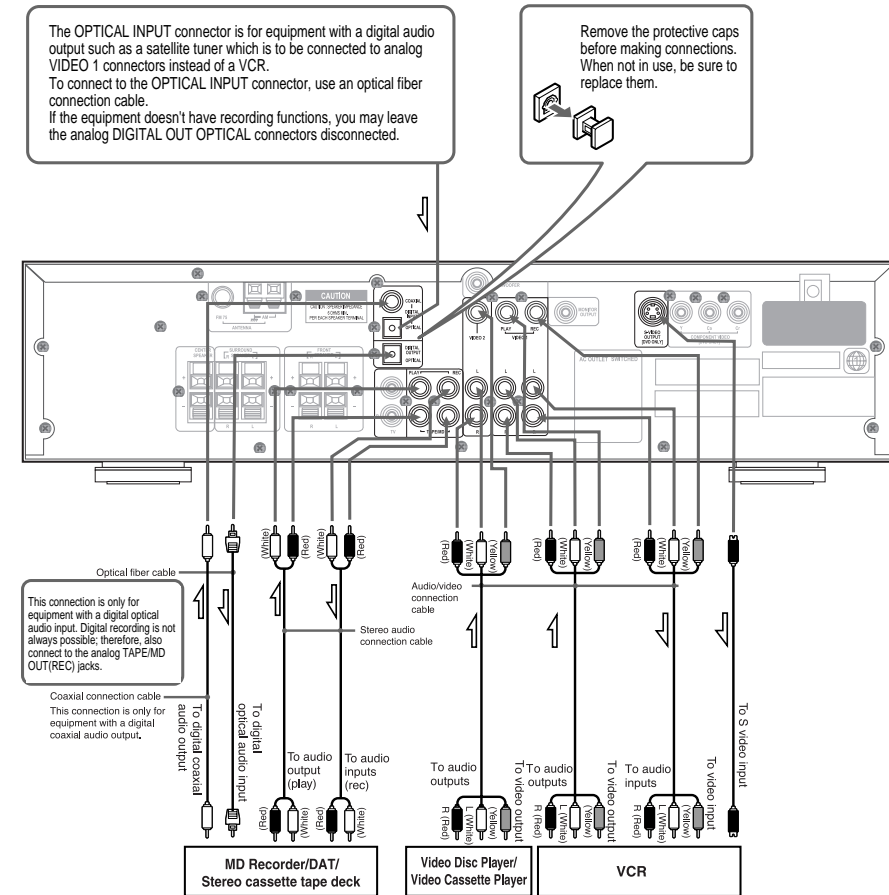

Getting Started